

Compact Disc Player

Operating Instructions



CDP-CX53

WARNING

To prevent fire or shock hazard, do not expose the unit to rain or moisture.

To avoid electrical shock, do not open the cabinet. Refer servicing to qualified personnel only.

For the customers in the United States

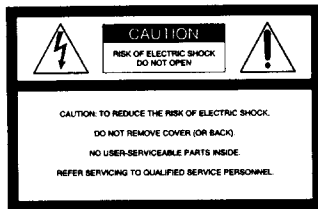

 This symbol is intended to alert the user to the presence of uninsulated "dangerous voltage" within the product's enclosure that may be of sufficient magnitude to constitute a risk of electric shock to persons.

 This symbol is intended to alert the user to the presence of important operating and maintenance (servicing) instructions in the literature accompanying the appliance.

INFORMATION

This equipment has been tested and found to comply with the limits for a Class B digital device, pursuant to Part 15 of the FCC Rules. These limits are designed to provide reasonable protection against harmful interference in a residential installation. This equipment generates, uses, and can radiate radio frequency energy and, if not installed and used in accordance with the instructions, may cause harmful interference to radio communications. However, there is no guarantee that interference will not occur in a particular installation. If this equipment does cause harmful interference to radio or television reception, which can be determined by turning the equipment off and on, the user is encouraged to try to correct the interference by one or more of the following measures:

- Reorient or relocate the receiving antenna.
- Increase the separation between the equipment and receiver.
- Connect the equipment into an outlet on a circuit different from that to which the receiver is connected.
- Consult the dealer or an experienced radio/TV technician for help.

CAUTION

You are cautioned that any changes or modification not expressly approved in this manual could void your authority to operate this equipment.

Owner's Record

The model and serial numbers are located at the rear of the unit. Record the serial number in the space provided below. Refer to them whenever you call upon your Sony dealer regarding this product.

Model No. _____
Serial No. _____

For the customers in Canada

CAUTION
TO PREVENT ELECTRIC SHOCK, DO NOT USE THIS POLARIZED AC PLUG WITH AN EXTENSION CORD, RECEPTACLE OR OTHER OUTLET UNLESS THE BLADES CAN BE FULLY INSERTED TO PREVENT BLADE EXPOSURE.

(Except for the customers in the United States and Canada)

The following caution label is located inside the unit.

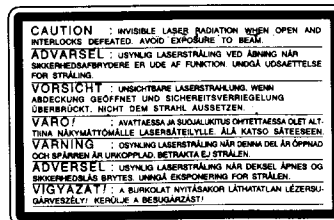

This appliance is classified as a CLASS 1 LASER product.

The CLASS 1 LASER PRODUCT MARKING is located on the rear exterior.

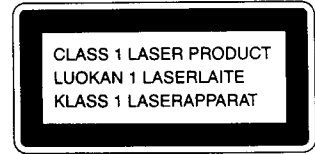

This equipment is intended for home entertainment purposes only. The warranty shall be invalidated if used in commercial environments, such as by disc jockeys, etc., even within the Warranty Period.



Welcome!

Thank you for purchasing the Sony Compact Disc Player. Before operating the unit, please read this manual thoroughly and retain it for future reference.

About This Manual

The instructions in this manual are for model CDP-CX53.

Conventions

- Instructions in this manual describe the controls on the player. You can also use the controls on the remote if they have the same or similar names as those on the player.
- The following icons are used in this manual:



Indicates that you can do the task using the remote.



Indicates hints and tips for making the task easier.

TABLE OF CONTENTS

Getting Started

Unpacking	4
Hooking Up the System	4
Inserting CDs	6

Playing a CD	8
--------------------	---

Playing CDs

Locating a Specific Disc	10
Specifying the Next Disc to Play	10
Locating a Specific Track or a Point in a Track	10
Playing Repeatedly	11
Playing in Random Order (Shuffle Play)	12
Creating Your Own Program (Program Play)	13
Playing Your Favorite Disc Independently (Plus One Play)	15
Playing Discs in a Group (Block Play)	16

Additional Information

Precautions	17
Notes on CDs	17
Troubleshooting	18
Specifications	18

Index	19
-------------	----

Unpacking

Check that you received the following items:

- Audio cord (1)
- CONTROL A1 cord (1) (supplied for Canadian models only)
- Remote commander (remote) (1)
- Sony SUM-3 (NS) batteries (2)
- CD booklet holder (1) and label (1)

💡 How to use the CD booklet holder

The CD booklet holder helps you locate the disc easily. After you have inserted discs into the player, you can put the CD booklet (which comes with a CD) into the supplied holder. Stick the number label on each pocket, matching the number of the disc slot where you have inserted the disc. You can put up to 50 CD booklets into the holder.

Inserting batteries into the remote

You can control the player using the supplied remote. Insert two R6 (size AA) batteries by matching the + and - on the batteries. When using the remote, point it at the remote sensor  on the player.

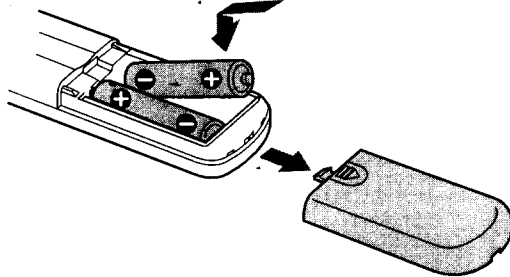

💡 When to replace batteries

With normal use, the batteries should last for about six months. When the remote no longer operates the player, replace all the batteries with new ones.

Notes

- Do not leave the remote near an extremely hot or humid place.
- Do not drop any foreign object into the remote casing, particularly when replacing the batteries.
- Do not expose the remote sensor to direct sunlight or lighting apparatuses. Doing so may cause a malfunction.
- If you do not use the remote for an extended period of time, remove the batteries to avoid possible damage from battery leakage and corrosion.

Hooking Up the System

Overview

This section describes how to hook up the CD player to an amplifier. Be sure to turn off the power of each component before making the connections.

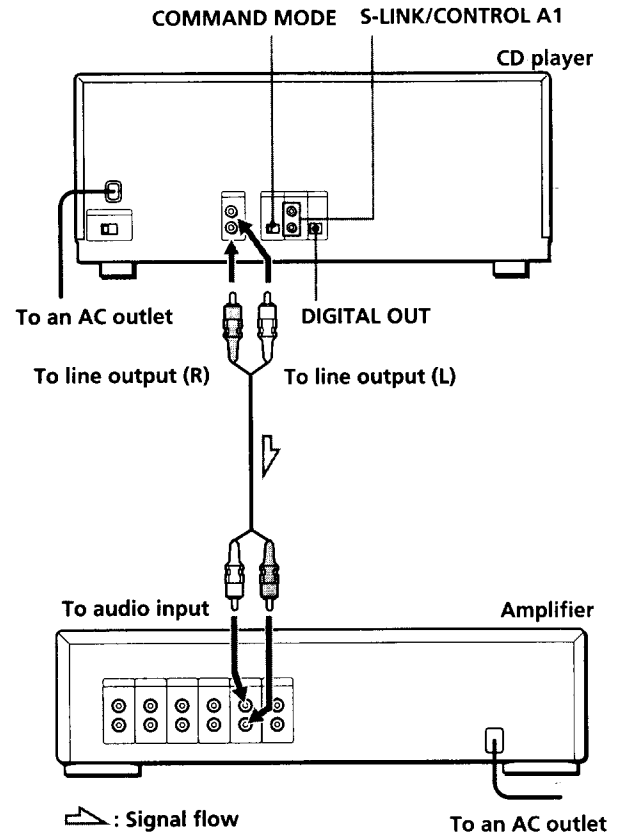

What cords will I need?

Audio cord (1) (supplied)

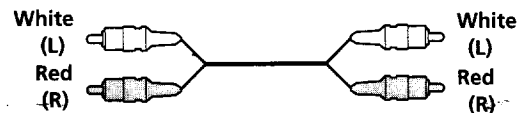

Hookups

When connecting the audio cord, be sure to match the color-coded cord to the appropriate jacks on the components: Red (right) to Red and White (left) to White. Be sure to make connections firmly to avoid hum and noise.

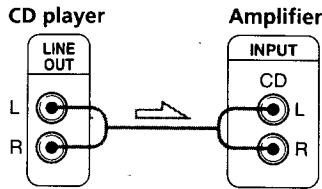

- **If you have a digital component such as a digital amplifier, D/A converter, DAT or MD**

Connect the component via the DIGITAL OUT (OPTICAL) connector using an optical cable (not supplied). Take off the cap and plug in the optical cable.

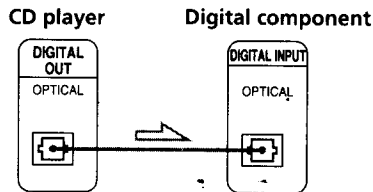
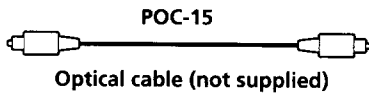

Note

When you connect via the DIGITAL OUT (OPTICAL) connector, noise may occur when you play CD software other than music, such as a CD-ROM.

- **If you have a Sony receiver (amplifier) equipped with the CONTROL A1 jack**

Be sure to connect the player to the CD IN jacks on the receiver (amplifier). When making this connection, set the COMMAND MODE of the player to CD1. If you further connect the player and the receiver (amplifier) via the CONTROL A1 jacks with the CONTROL A1 cord (supplied for Canadian models only), you can use the Auto Function feature between these components. For details, refer to the supplementary "S-Link™/CONTROL-A1 Control System" instructions and the instructions supplied with the receiver (amplifier).

💡 When to use the COMMAND MODE selector

The COMMAND MODE selector is set to CD1 at the factory for normal use. You can control this player by connecting to a Sony CD player with the player control function, via the CONTROL A1 jacks. When making this connection, set the COMMAND MODE selectors of each player to the appropriate position according to the connected line input jacks. For details, refer to the instructions supplied with the connected player.

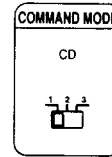

💡 When using another Sony CD player together with this player

You can make the supplied remote effective only for this player.

- When using the player equipped with the COMMAND MODE selector:
Set the COMMAND MODE selector of this player to CD1 and that of another player to CD2 or CD3. Then set the CD1/2/3 switch on the remote supplied for each player accordingly.
- When using the player not equipped with the COMMAND MODE selector:
The command mode of the player without the COMMAND MODE selector is set to CD1. Set the COMMAND MODE selector of this player to CD2, and set the CD1/2/3 switch on the remote to CD2.

Setting the voltage selector (voltage selector equipped models only)

Check that the voltage selector on the rear panel of the player is set to the local power line voltage. If not, set the selector to the correct position using a screwdriver before connecting the AC power cord to a wall outlet.

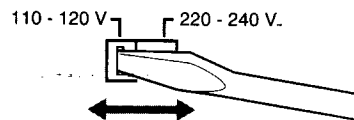

Getting Started

Connecting the AC power cord

Connect the AC power cord to a wall outlet.

Note on placement

Be sure to place the player on a horizontal place. If the player is slanted, it may cause a malfunction or damage the player.

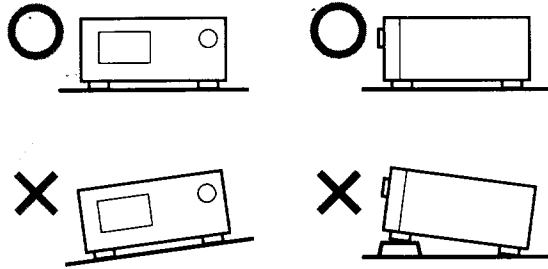

Inserting CDs

You can insert up to 51 discs into this player.

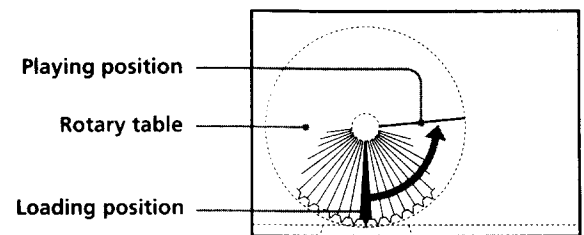
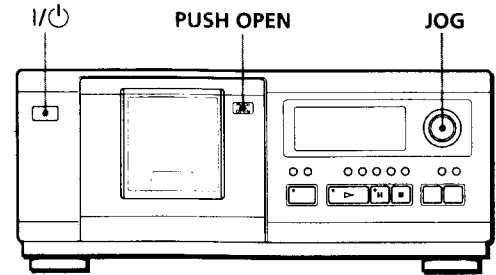

- 1 Press I/O to turn on the player.
- 2 Open the front cover by pushing PUSH OPEN of the cover.

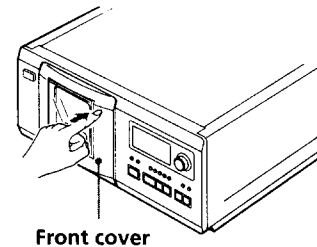

- 3 Turn the JOG dial until you find the disc slot where you want to insert a disc, while checking the disc number (written beside every slot and also indicated in the display).

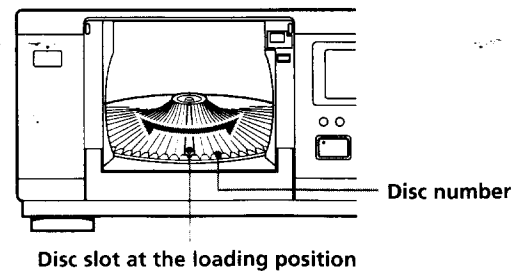

The disc number at the loading position appears in the display.* As you turn the JOG dial, the disc number changes.

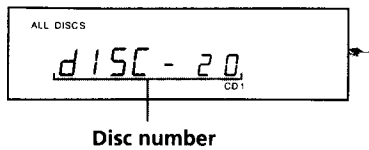

You can play the disc you want independently by using the Plus One function. When using this function, insert the disc into the PLUS ONE slot. For details, see "Playing Your Favorite Disc Independently" on page 15.

You can arrange your discs into groups and play them within a certain group using the Block Play function. When using this function, you have to insert discs into the slots assigned to one of the five blocks. For details, see "Playing Discs in a Group" on page 16.

* If you have already inserted discs, the disc number at the playing position appears.

4 Insert a disc with the label side facing right.

Notes

- Make sure you have inserted the disc into each slot at a right angle to the rotary table. If the disc is not put in straight, it may damage the player or the disc.
- Make sure the rotary table comes to a complete stop before inserting or removing discs.

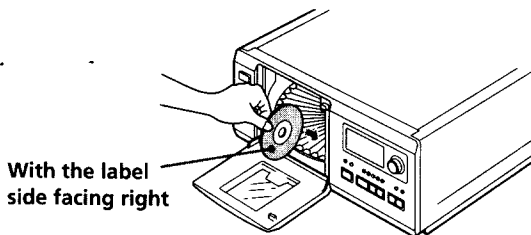

5 Repeat Steps 3 and 4 to insert more discs.

6 Close the front cover by pushing PUSH OPEN of the cover until it clicks.

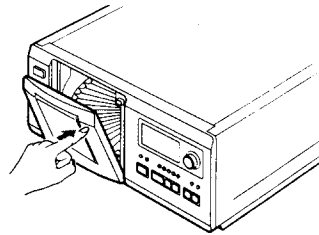

The rotary table turns and the disc slot at the loading position is set to the playing position. Always close the front cover except when you insert or remove discs.

The supplied CD booklet holder helps you locate a disc

You can store up to 50 CD booklets.

Notes

- Do not insert an empty 8 cm (3-inch) CD adaptor (CSA-8). It may damage the player.
- Do not attach anything such as seals or sleeves to CDs. It may damage the player or the disc.
- If you drop a disc into the player and the CD won't go into the slot correctly, consult your nearest Sony dealer.
- When transporting the player, remove all discs from the player.

Removing CDs

After following Steps 1 to 3 of "Inserting CDs" on pages 6 - 7, remove the discs. Then close the front cover.

Note



The disc being played does not come to the loading position if you open the front cover. (The disc number flashes in the display.)

If you want to remove the disc being played, push the JOG dial after opening the front cover. The disc comes to the loading position. Remove the disc after the rotary table comes to a complete stop.

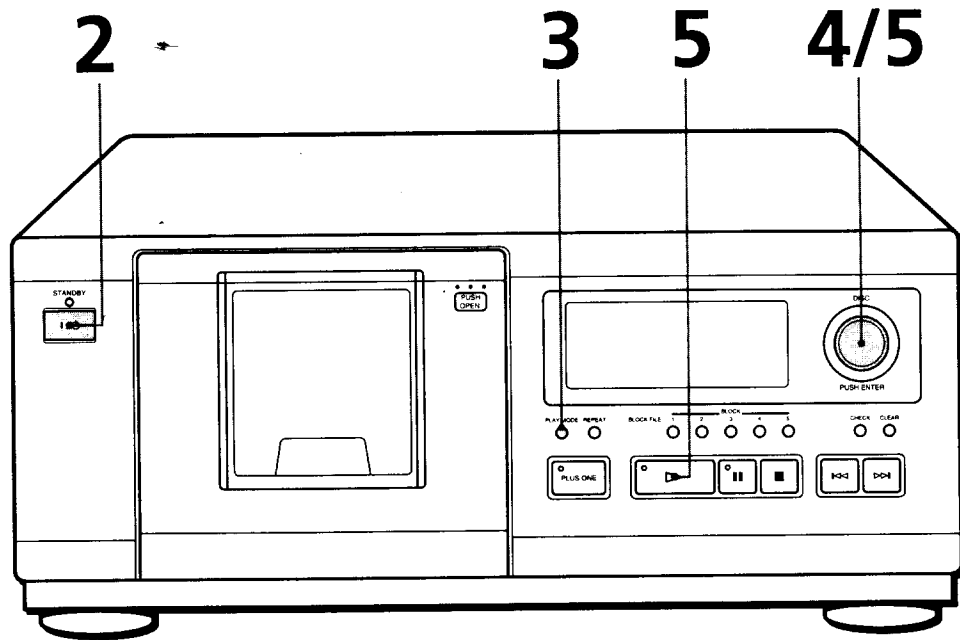
Playing a CD



- See pages 4 – 5 for the hookup information.
- Make sure you have inserted the discs correctly as indicated on page 6.
- You can play all the tracks on a disc in the original order (Continuous Play). You can also play up to 51 discs consecutively.

 You can turn on the player by pressing I/⏻ on the remote 

- 1 Turn on the amplifier and select the CD player position.
- 2 Press I/⏻ to turn on the player.
- 3 Press PLAY MODE to select ALL DISCS or 1 DISC Continuous Play mode.

When you select	The player plays
ALL DISCS	All discs in the player consecutively in the order of disc number. Empty disc slots are skipped.
1 DISC	Only the one disc you have selected

- 4 Turn the JOG dial until the disc number you want appears in the display to select the first disc (ALL DISCS) or the disc you want (1 DISC).

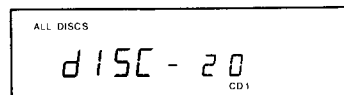

- 5 Push the JOG dial or press \blacktriangleright to start playing.
 The selected disc is set to the playing position, and the player plays all the discs from the selected one (ALL DISCS) or all the tracks once (1 DISC).
 Adjust the volume on the amplifier.

💡 When you turn off the player by pressing the I/O (standby mode)

The player remembers the last playing disc and the play mode (Continuous, Shuffle (see page 12) or Program (see page 13)). When you turn on the player again, therefore, the player plays the same disc in the same play mode. Note that the player does not remember this information, if you turn off the player by pressing the power switch of the amplifier or receiver while the AC power cord is connected to the switched AC outlet of the amplifier or receiver.

Display information while playing a disc

While playing a disc, the display shows the current disc number, track number, playing time of the track and the next disc number.

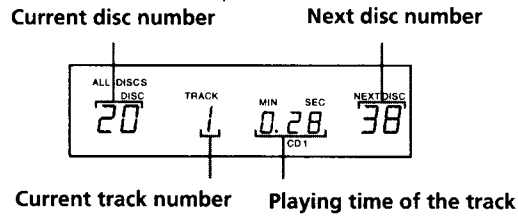

To stop playback

Press \blacksquare .

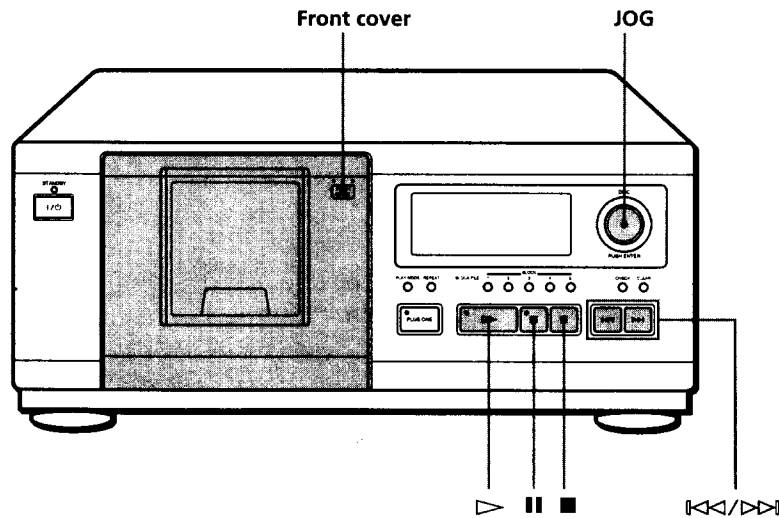

To	You need to
Pause	Press II
Resume playing after pause	Press II or \blacktriangleright
Go to the next disc \uparrow	Press DISC SKIP + once. Hold down the button to skip discs.
Go back to the preceding disc \downarrow	Press DISC SKIP - once. Hold down the button to skip discs.
Go to the next track	Press \blacktriangleright
Go back to the preceding track	Press \blacktriangleleft
Stop playing and remove the disc	Open the front cover, then push the JOG dial. The disc comes to the loading position.

Locating a Specific Disc

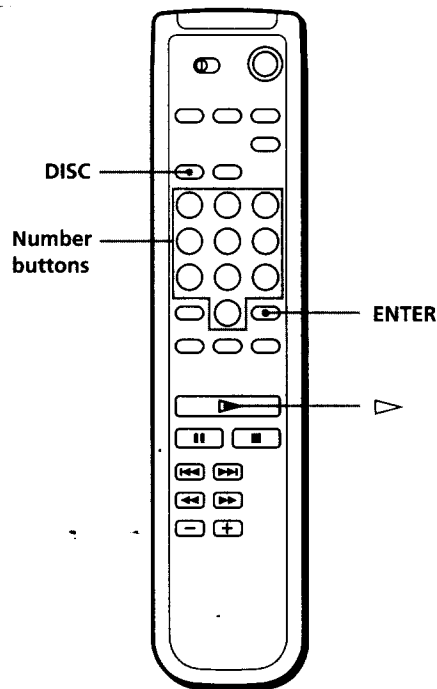
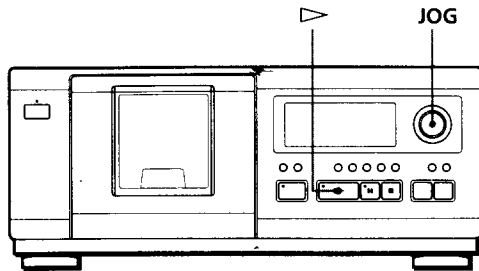

Selecting a disc on the player

Turn the JOG dial until the disc number you want appears in the display. Push the JOG dial or press to start play.

Selecting a disc directly using the remote

- 1 Press DISC.
- 2 Press the number button of the disc.
Example: To enter number 35
Press 3, then 5.
- 3 Press ENTER or press to start play.

To cancel the disc you have selected
Press CLEAR.

Specifying the Next Disc to Play

You can specify the next disc to play while playing a disc in Continuous or 1 DISC Shuffle Play mode.

While playing a disc, turn the JOG dial until the disc number you want appears in the display.



After the current disc is played, the next disc you have specified starts playing.

If you want to skip to the next disc right away, push the JOG dial while playing the current disc.

To cancel the disc you have specified
Press CONTINUE twice.

Locating a Specific Track or a Point in a Track

You can quickly locate any track while playing a disc using the (AMS: Automatic Music Sensor) buttons. You can also locate a specific point in a track while playing a disc.

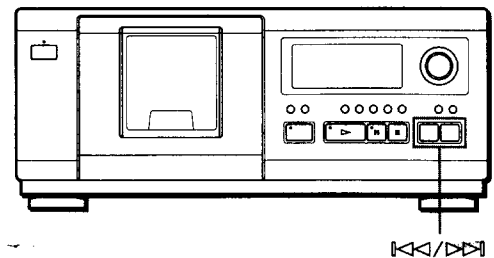

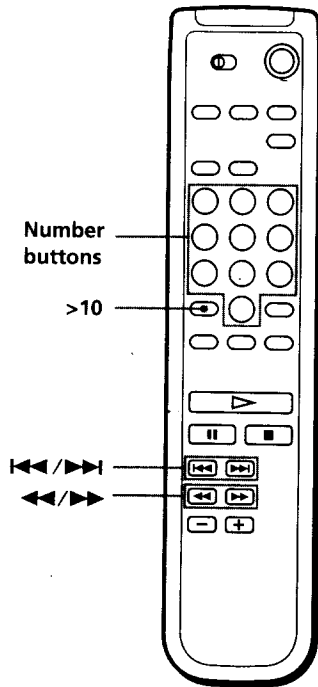

To locate	Press
the next or succeeding tracks	▶▶ repeatedly until you find the track
the current or preceding tracks	◀◀ repeatedly until you find the track
a specific track directly	The number button of the track on the remote. When you locate a track with a number over 10, press >10 first, then press the 10's digit and 1's digit.
a point in a track while monitoring the sound .	▶▶ (forward) or ◀◀ (backward) and hold down until you find the point
a point in a track quickly by observing the display	▶▶ (forward) or ◀◀ (backward) and hold down until you find the point during pause. You will not hear the sound during the operation.

Note

If " 7 7 " appears in the display, the disc has reached the end while you were pressing ▶▶ on the remote. Press ◀◀ or ◀◀ on the remote to go back.

Playing Repeatedly

You can play discs/tracks repeatedly in any play mode.

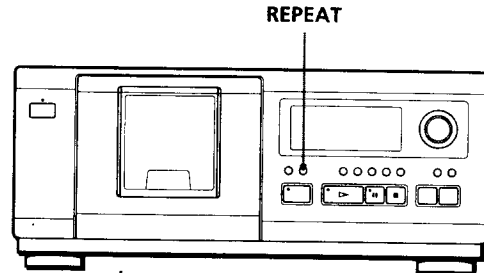

Press REPEAT while playing a disc. "REPEAT" appears in the display. The player repeats the discs/tracks as follows:

When the disc is played in	The player repeats
ALL DISCS Continuous Play (page 8)	All tracks on all discs
1 DISC Continuous Play (page 8)	All tracks on the current disc
ALL DISCS Shuffle Play (page 12)	The player does not repeat discs/tracks but keeps shuffling until you stop play whether or not you press REPEAT.
1 DISC Shuffle Play (page 12)	All tracks on the current disc in random order
Program Play (page 13)	The same program

To cancel Repeat Play

Press REPEAT twice.

Repeating the current track

You can repeat only the current track.

While the track you want is being played, press REPEAT repeatedly until "REPEAT 1" appears in the display.

To cancel Repeat 1

Press REPEAT.

Playing in Random Order (Shuffle Play)

You can have the player "shuffle" the tracks and play in random order. The player shuffles all the tracks on all discs or on the disc you specified.

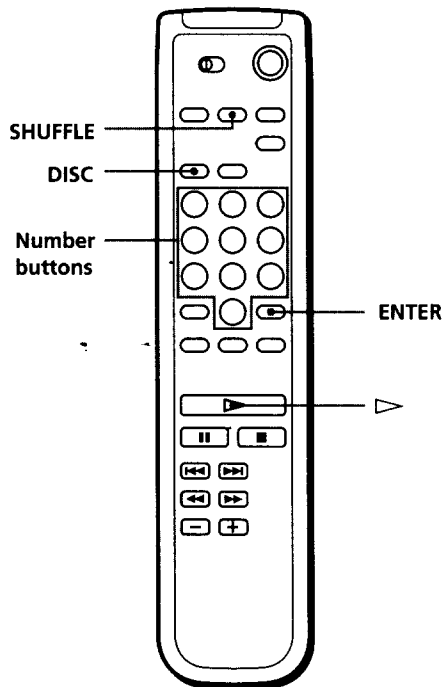
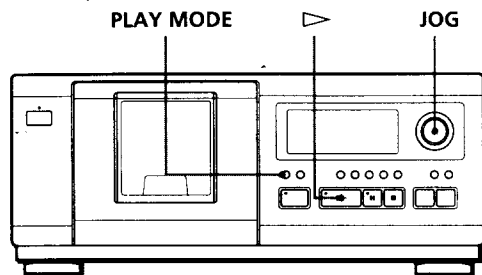

Playing all tracks on a specified disc in random order

- 1** Press PLAY MODE repeatedly until "1 DISC" and "SHUFFLE" appear in the display. When using the remote, press SHUFFLE twice.
- 2** Turn the JOG dial until the disc number you want appears in the display. When using the remote, press DISC first and then press the number button of the disc.
- 3** Push the JOG dial or press ▷. When using the remote, press ENTER. 1 DISC Shuffle Play starts. " [] " appears in the display while the player is "shuffling" the tracks.

To cancel Shuffle Play

Press PLAY MODE repeatedly until "SHUFFLE" disappears from the display. When using the remote, press CONTINUE.

💡 You can start Shuffle Play while playing

Press PLAY MODE repeatedly until "SHUFFLE" appears in the display. When using the remote, press SHUFFLE. Shuffle Play starts from the current track.

💡 You can specify the next disc to play during 1 DISC Shuffle Play

Turn the JOG dial to specify the next disc. After all the tracks on the current disc are played in random order, the next disc starts playing. If you want to skip to the next disc right away, push the JOG dial while playing the current disc.

Note

You cannot specify the next disc to play during ALL DISCS Shuffle Play.

Playing all tracks on all discs in random order

- 1** Press PLAY MODE repeatedly until "ALL DISCS" and "SHUFFLE" appear in the display. When using the remote, press SHUFFLE.
- 2** Push the JOG dial or press ▷. ALL DISCS Shuffle Play starts. " [] " appears in the display while the player is "shuffling" the discs or the tracks.

Note that ALL DISCS Shuffle Play continues until you press ■.

Creating Your Own Program (Program Play)

You can arrange the order of the tracks and/or discs to create your own program and the program is stored automatically. A program can contain up to 32 "steps" — one "step" may contain a track or a whole disc. You can make a program using the controls on the remote as well as ones on the player. However, the programming procedures are different.

Creating a program on the player

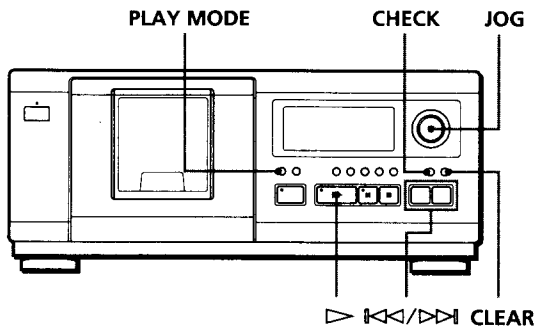

- 1 Press PLAY MODE repeatedly until "PROGRAM" appears in the display. If a program is already stored, the last step of the program appears in the display. When you want to erase the whole program, hold down CLEAR until "Clear" appears in the display (see page 14).
- 2 Turn the JOG dial until the disc number you want appears in the display.

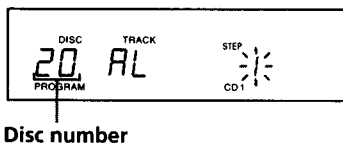

Disc number

- 3 To program a whole disc, skip this step. Press \lll/\ggg until the track number you want appears in the display.

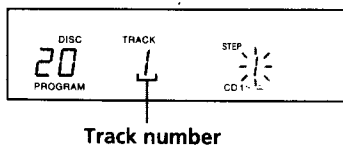

Track number

- 4 Push the JOG dial.

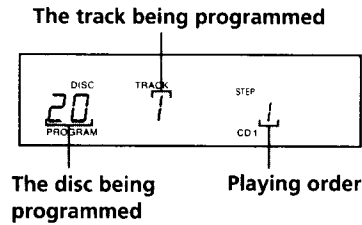

- 5 To program other discs/tracks, do the following:

To program	Repeat Steps
All tracks of another disc(s)	2 and 4
Other tracks on the same disc	3 and 4
Other tracks on other discs	2 to 4

- 6 Push the JOG dial or press \triangleright to start Program Play.

To cancel Program Play

Press PLAY MODE.

💡 The program remains even after Program Play ends
When you push the JOG dial or press \triangleright , you can play the same program again.

💡 When you press PLAY MODE to select Program Play during Continuous or Shuffle Play
The program will be played after the current track.

💡 The program remains until you erase them
Even if you replace discs, the programmed disc and track numbers remain. So, the player plays only the existing disc and track numbers. However, the disc and track numbers that are not found in the player or on the disc are deleted from the program, and the rest of the program is played in the programmed order.

Note

If you press one of the BLOCK 1 – 5 buttons (see page 16) or the PLUS ONE button (see page 15) during Program Play, Program Play will be canceled.

Creating a program using the remote

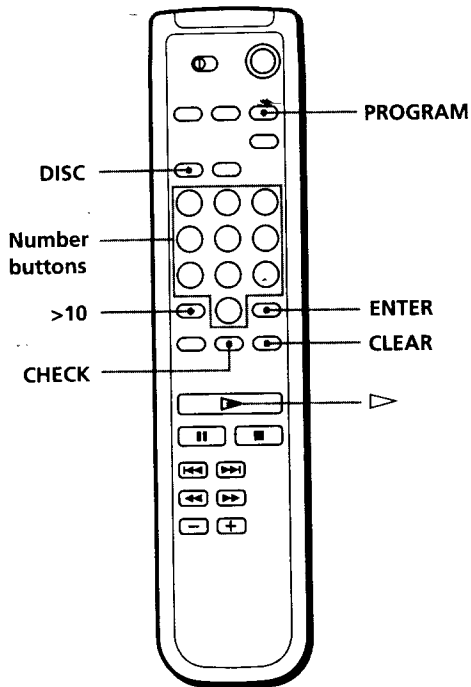

- 1** Press PROGRAM.
- 2** Press DISC.
- 3** Press the number button of the disc.
- 4** To program a whole disc, press ENTER and go to Step 6.
- 5** Press the >10 button, then the number button of the track.
- 6** To program other discs/tracks, do the following:

To program	Repeat Steps
All tracks of another disc(s)	2 to 4
Other tracks on the same disc	5
Other tracks on other discs	2, 3 and 5

- 7** Press  to start Program Play.

To cancel Program Play

Press CONTINUE.

Checking the programmed order

You can check your program before or after you start playing.

Press CHECK.

Each time you press this button, the display shows the disc and track number of each step in the programmed order. (When a whole disc is programmed as one step, "AL" appears instead of the track number.) After the last step in the program, the display shows "End" and returns to the original display.

Changing the programmed order

You can change your program before you start playing.

To	You need to
Erase a track or disc	Press CHECK until the track or disc you want to erase appears in the display, then press CLEAR
Erase the last track or disc in the program	Press CLEAR. Each time you press the button, the last track or disc will be cleared.
Add tracks or discs to the end of the program	Follow the programming procedure
Change the whole program completely	Hold down CLEAR until "Clear" appears in the display to erase the whole program, then create a new program following the programming procedure

Erasing the program stored in memory

- 1** Press PLAY MODE repeatedly until "PROGRAM" appears in the stop mode. When using the remote, press PROGRAM.
- 2** Hold down CLEAR until "Clear" appears in the display.

Playing Your Favorite Disc Independently (Plus One Play)

When you insert a disc into the PLUS ONE slot, you can play the disc independently from other discs. The play mode you have selected (except for Program Play) remains active even if you use this function.

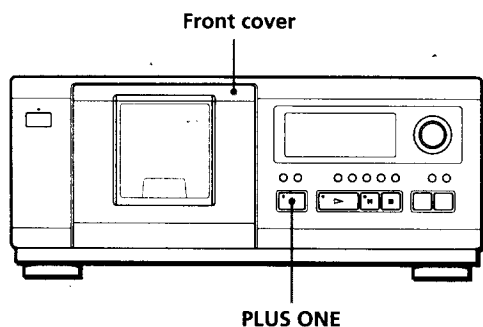

- 1 Open the front cover.
- 2 Press PLUS ONE.
The indicator on the PLUS ONE button lights up.

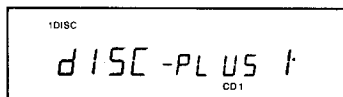

The PLUS ONE slot comes to the loading position.

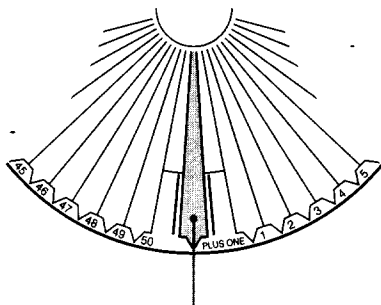

PLUS ONE slot

- 3 Insert a disc into the PLUS ONE slot.
- 4 Close the front cover.
"P1" appears in the display instead of the disc number, and the player starts playing the disc in the PLUS ONE slot.

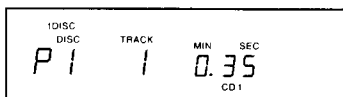

To cancel Plus One Play

Press PLUS ONE. The indicator on the PLUS ONE button goes off. The disc number in the display changes to 51 and you can play the disc as the 51st disc.

💡 If you have already inserted a disc into the PLUS ONE slot
Press PLUS ONE while the front cover is closed. Plus One Play starts immediately.

💡 You can change the play mode by pressing the PLAY MODE button before Step 4

Notes

- When you press the PLUS ONE button, ALL DISCS Play mode is automatically set to 1 DISC Play mode.
- Plus One Play will be canceled if you turn the JOG dial or press buttons to specify another disc or to select another play mode.
- The PLUS ONE slot comes to the loading position automatically if you open the front cover during Plus One Play. Do not put your hand inside the compartment nor change the disc before the rotary table comes to a complete stop. If you do, you may injure your hand or damage the disc.

Playing Discs in a Group (Block Play)

You can classify discs in advance by artists, category, etc. when inserting discs into the slots, and play them only within the group (called "block") you specified. The player has five blocks, and each slot is assigned to one of the blocks as shown below.

Block number	Disc slot
1	1-10
2	11-20
3	21-30
4	31-40
5	41-51

You can enjoy Continuous, Shuffle or Repeat Play within a certain block.

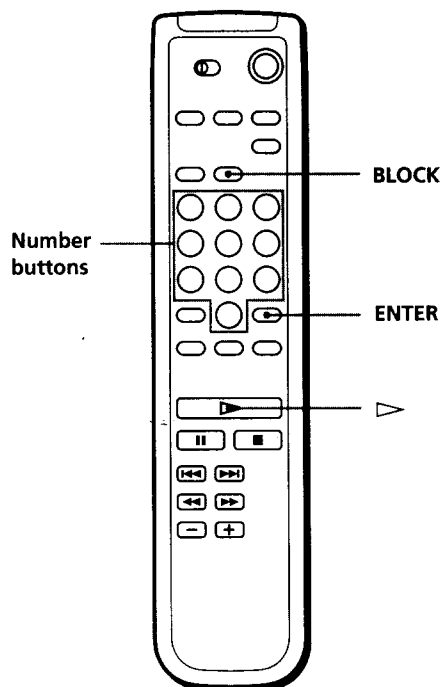
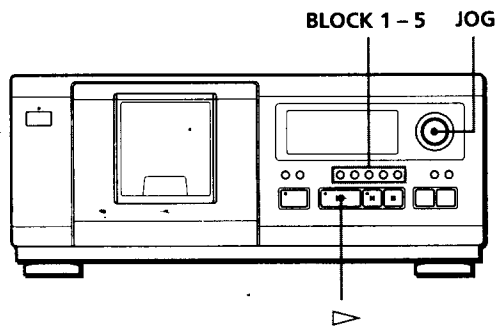

- 1 Insert discs into the slot of the block you want, referring to the table on page 16 (see also "Inserting CDs" on page 6).
- 2 Press one of the BLOCK 1 - 5 buttons to select the block.
When using the remote, press BLOCK, the number button of the block you want, then ENTER. The block number appears in the display.
- 3 Push the JOG dial or press ▷.
Block Play starts from the disc which is the most upward number within a block and located closest to the playing position.

💡 You can start Block Play from the disc you want
When you want to start Block Play from the disc you want, turn the JOG dial to select the disc after Step 2, then push the JOG dial or press ▷.

To cancel Block Play

Press the corresponding BLOCK 1 - 5 button.

Notes

- The block number does not appear if no disc is put into the block you specified.
- Block Play will be canceled if you press the PLAY MODE button or the PROGRAM button on the remote to select Program Play.
- Block Play will be canceled if you press the PLUS ONE button.

Precautions

On safety

- Caution — The use of optical instruments with this product will increase eye hazard.
- Should any solid object or liquid fall into the cabinet, unplug the player and have it checked by qualified personnel before operating it any further.

On power sources

- Before operating the player, check that the operating voltage of the player is identical with your local power supply. The operating voltage is indicated on the nameplate at the rear of the player.
- The player is not disconnected from the AC power source (mains) as long as it is connected to the wall outlet, even if the player itself has been turned off.
- If you are not going to use the player for a long time, be sure to disconnect the player from the wall outlet. To disconnect the AC power cord (mains lead), grasp the plug itself; never pull the cord.
- AC power cord must be changed only at the qualified service shop.

On placement

- Place the player in a location with adequate ventilation to prevent heat build-up in the player.
- Do not place the player on a soft surface such as a rug that might block the ventilation holes on the bottom.
- Do not place the player in a location near heat sources, or in a place subject to direct sunlight, excessive dust or mechanical shock.

On operation

- If the player is brought directly from a cold to a warm location, or is placed in a very damp room, moisture may condense on the lenses inside the player. Should this occur, the player may not operate properly. In this case, leave the player turned on for about an hour until the moisture evaporates.

On adjusting volume

- Do not turn up the volume while listening to a portion with very low level inputs or no audio signals. If you do, the speakers may be damaged when a peak level portion is played.

On cleaning

- Clean the cabinet, panel and controls with a soft cloth slightly moistened with a mild detergent solution. Do not use any type of abrasive pad, scouring powder or solvent such as alcohol or benzine.

On transportation

- When transporting the player, open the front cover then remove all the discs from the player and turn the power off.

If you have any questions or problems concerning your player, please consult your nearest Sony dealer.

Notes on CDs

On handling CDs

- To keep the disc clean, handle the disc carefully.
- Do not stick paper or tape on the disc.



Not this way

- Do not expose the disc to direct sunlight or heat sources such as hot air ducts, nor leave it in a car parked in direct sunlight as there can be considerable rise in temperature inside the car.
- After removing a disc from the disc slot, store the disc in its case.

On cleaning

- Before playing, clean the disc with a cleaning cloth. Wipe the disc from the center out.



- Do not use solvents such as benzene, thinner, commercially available cleaners or anti-static spray intended for vinyl LPs.

Troubleshooting

If you experience any of the following difficulties while using the player, use this troubleshooting guide to help you remedy the problem. Should any problem persist, consult your nearest Sony dealer.

There is no sound.

- ➔ Check that the player is connected securely.
- ➔ Make sure you operate the amplifier correctly.

The CD does not play.

- ➔ There is no CD in a slot ("no dISC" appears). Insert a CD.
- ➔ Insert the CD with the label side facing right.
- ➔ Clean the CD (see page 17).
- ➔ Moisture has condensed inside the player. Open the front cover and leave the player turned on for about an hour (see page 17).

The remote does not function.

- ➔ Remove obstacles in the path of the remote and the player.
- ➔ Point the remote at the remote sensor  on the player.
- ➔ Replace all the batteries in the remote with new ones if they are weak.
- ➔ Set the CD1/2/3 switch on the remote according to the position of the COMMAND MODE selector displayed in the front panel display (see page 5).

The player functions incorrectly.

- ➔ The microcomputer chips may be operating incorrectly. Disconnect the AC power cord, then connect it back to the wall outlet to reset the player.

Specifications

Compact disc player

Laser	Semiconductor laser ($\lambda = 780 \text{ nm}$) Emission duration: continuous
Laser output	Max 44.6 μW^* * This output is the value measured at a distance of 200 mm from the objective lens surface on the Optical Pick-up block with 7 mm aperture.
Frequency response	2 Hz to 20 kHz $\pm 1 \text{ dB}$
Signal-to-noise ratio	More than 100 dB
Dynamic range	More than 88 dB
Harmonic distortion	Less than 0.013 %
Channel separation	More than 95 dB

Output

	Jack type	Maximum output level	Load impedance
LINE OUT	Phono jacks	2 V (at 50 kilohms)	Over 10 kilohms
DIGITAL OUT (OPTICAL)	Optical output connector	-18 dBm	Wave length: 660 nm

General

Power requirements

Where purchased	Power requirements
USA/Canada	120 V AC, 60 Hz
Australia	240 V AC, 50 Hz
Europe	220 V - 230 V AC, 50/60 Hz
Other countries	110 V - 120 V or 220 V - 240 V AC, adjustable, 50/60 Hz

Power consumption 12 W

Dimensions (approx.) (w/h/d)
When the front cover is closed
430 × 182.5 × 295 mm (17 × 7 1/4 × 11 5/8 in.) incl. projecting parts
When the front cover is open
430 × 182.5 × 414 mm (17 × 7 1/4 × 16 3/8 in.) incl. projecting parts

Mass (approx.) 5.2 kg (11 lbs 8 oz)

Supplied accessories

- Audio cord (2 phono plugs - 2 phono plugs) (1)
- CONTROL A1 cord (supplied for Canadian models only) (1)
- Remote commander (remote) (1)
- Sony SUM-3 (NS) batteries (2)
- CD booklet holder (1)
- Label (1)

Design and specifications are subject to change without notice.

Index

A

AMS 10
Automatic Music Sensor 10

B

Block Play 16

C, D

Connecting 4
Continuous Play 8

E, F, G

Erasing
programs 14

H

Handling CDs 17
Hookups
overview 4

I

Inserting CDs 6

J, K

JOG dial 6, 8

L, M, N, O

Locating
a specific track 11
a specific point 11
by monitoring 11
by observing the display 11
discs 10
using AMS 11

P, Q

Playback
Block Play 16
Continuous Play 8
Program Play 13
Repeat Play 11
Shuffle Play 12
Plus One Play 15
Program
changing 14
checking 14
erasing 14

R

Remote control 4
Repeating 11
Rotary table 6

S

Searching. *See* Locating
Selecting a disc 10
Shuffle Play
on all discs 12
on one disc 12
Specifying the next disc 10

T

Troubleshooting 18

U, V, W, X, Y, Z

Unpacking 4

Names of controls

Buttons

BLOCK 16
BLOCK 1-5 16
CHECK 14
CLEAR 14
CONTINUE 10
DISC 10
DISC SKIP 9
ENTER 10
Number 10
PLAY MODE 8
PLUS ONE 15
PROGRAM 14
REPEAT 11
SHUFFLE 12
◀◀/▶▶ 9
◀◀/▶▶ 11
▷ 9
|| 9
■ 9
>10 11

Switches

CD1/2/3 5
I/⏻ 6

Jacks

LINE OUT 5
S-LINK/CONTROL A1 5

Connectors

DIGITAL OUT (OPTICAL) 5

Others

Disc slots 6
Display 9
Front cover 6
JOG dial 6, 8
PUSH OPEN 6
Rotary table 6
■ 4